

PetTec

Pet Cam Free'n 360°

WiFi Version

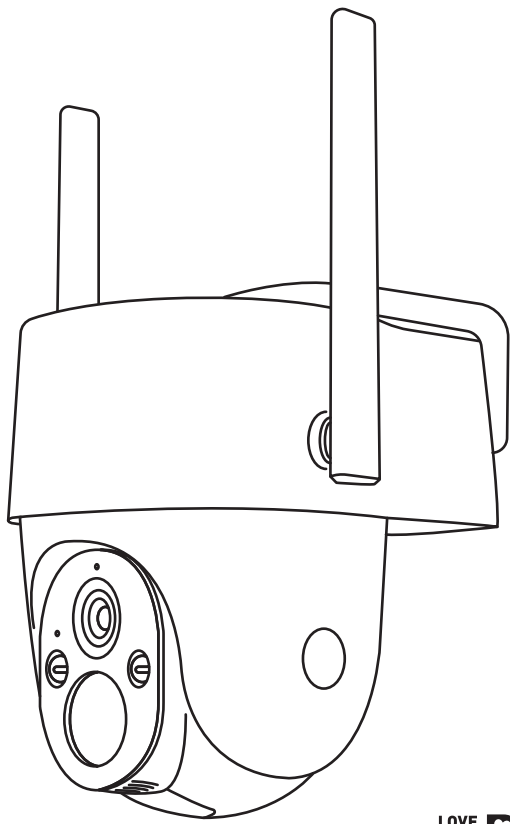

LOVE
YOUR **PET**



HERE WE GO...

Thank you for choosing our pet cam. With the **PetTec Pet Cam Free'n 360° WiFi** you'll always have your darling in view.

Important safety instructions

READ ALL INSTRUCTIONS AND WARNINGS IN THIS OPERATING MANUAL BEFORE USING THE PET CAM Free'n 360° WiFi.

- Please do not disassemble and modify the PetTec Pet Cam Free'n 360° WiFi. The device requires neither maintenance nor servicing. In case of malfunction, please contact our customer service.
- In order to ensure proper use of the device, we recommend that you only use the original parts. Use only the supplied assembly parts for mounting the device.
- Keep the camera away from external exposure to ensure long term use. The device should not be affected by any renovation work, be it the use of paint or wallpaper.

Legal Notice

- The PetTec Pet Cam Free'n 360° WiFi has been designed for indoor and outdoor use only. Laws in your country may limit observation of areas outside of your home or property. Please inform yourself about local legislation. To protect the privacy of others, mount the camera so that you cannot record images of public areas, streets, or your neighbor's property. We also recommend informing relatives, visitors and domestic workers about the camera and its function.
- Please note that using the Pet Cam Free 360° does not automatically inform you via the app in emergencies or in the event of break-ins, for example. If necessary, an emergency call must always be made by you. Stage10 GmbH accepts no liability for missing or incorrect notifications or recordings.

PRODUCT OVERVIEW I

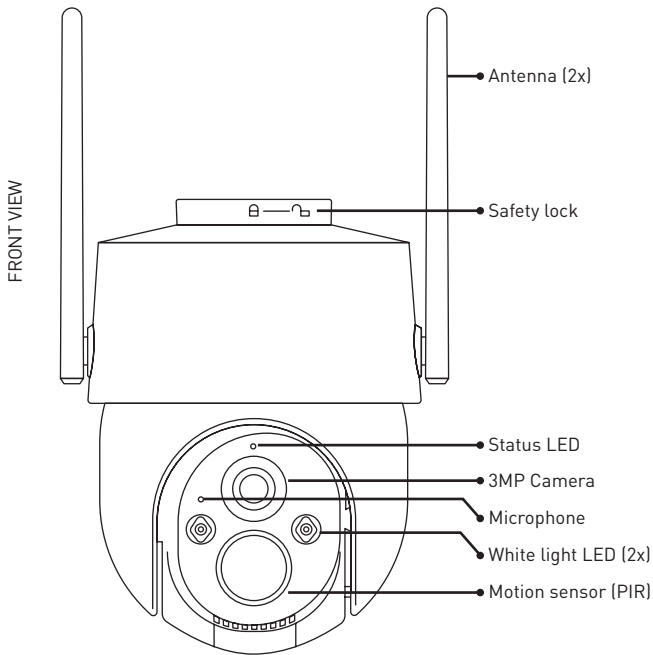



PRODUCT OVERVIEW II

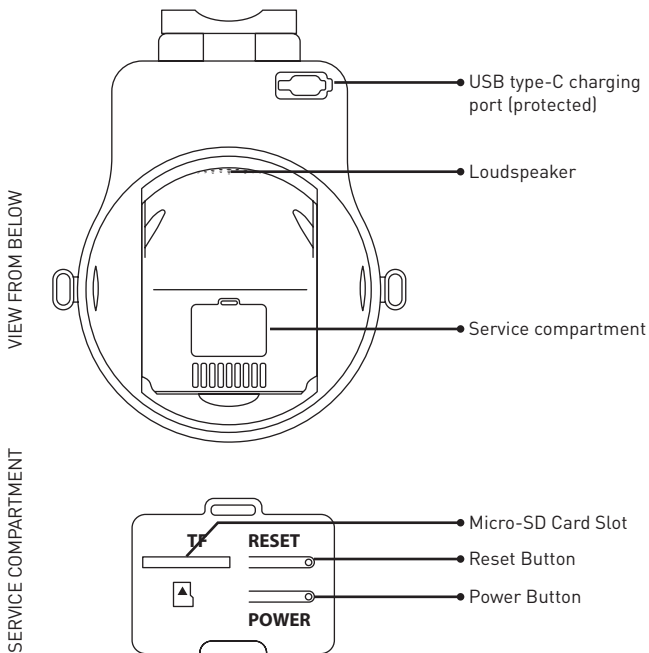

CONTENTS

- Pet Cam Free'n 360° WiFi
- Angle bracket
- 4 Screws + dowels
- 2 Metal loops
- USB type-C Cable
- Manual

IMPORTANT INSTRUCTIONS



Status LED display

- Red flashing LED - ready to connect to the Wi-Fi
 - Red fast flashing LED - Wi-Fi connection is being established
-
- Red & blue fast flashing LED - Wi-Fi connection cannot be established
-
- Steady blue LED - Camera is active (live stream or motion detection)
 - Flashing blue LED - The app is ready to connect to the camera
 - Flashing blue LED - Firmware update is being installed

Switching on and off

Press the power button in the service compartment for three seconds (until the LED lights up red) to switch the appliance on or off.

USB type-C cable

The connector supplies power to the camera. If required, conventional USB type-C cables with different lengths may be used.

Microphone/speaker

The combination of built-in microphone and speaker allows two-way communication.

Micro-SD card slot

The micro-SD card slot is located at the top of the treat tank under a cover (see diagram). Micro-SD cards up to 512 may be used.

Reset Button

The reset button must be pressed for approx. 5 seconds to reset the camera to the factory settings.



GETTING STARTED

1. Please connect the camera with a USB-C cable and plug it into the power plug (not supplied). The power plug must be connected to a power socket.
2. Switch the camera on by pressing the on/off button. The camera is then ready to be connected to the app.
3. Open the app (the QR code for downloading can be found below) and press the + symbol at the top right. Now select "Add".
4. A pop-up notification will appear at the bottom of the screen. Press it to connect the camera to the app.
5. Now select your Wi-Fi connection and enter the password.
6. Your smartphone must be connected to the Wi-Fi network of your router into which you also want to integrate the camera.
7. A stable Wi-Fi connection is essential to ensure proper functioning.

Important: Fully charge the device when using it for the first time or after a longer break. This can take up to 4 hours!



FEATURES



Pan/tilt

The camera image can be rotated/tilted in the app to obtain a viewing angle of almost 360 degrees.

Colour Vision

Thanks to the two white light LEDs, the recorded images and videos of motion detection are in colour.

Two-way audio

If you see a visitor in the camera's live view, you can speak to them and communicate with them via your app function.

PIR

If someone walks past, an alarm is triggered and sent to your smartphone.

Motion detection

The camera can be activated from a great distance (up to 30 metres) by detecting people. The camera sends you push notifications and app notifications as soon as human movement is detected.

Recording

Use a micro SD card or save events with the Cloud Event Service Cloud+ so you never miss a thing.

Day&Night

With the powerful night vision technology, you have a good view even in the dark (up to 20m).

AOV (Always on Video)

By using the latest AOV technology, the Pet Cam Free'n 360° enables permanent recording and event detection up to a distance of 30 metres. If a person is detected, the device immediately switches to live recording. If no person is detected, the device records energy and memory-saving videos at a frame rate set by the user.



MOUNTING THE CAMERA I



Mounting options:

You have numerous options for mounting the camera so that you can use it flexibly outdoors:

- Wall mounting
- Overhead mounting
- Setting up the camera
- Mounting on a tree or pole

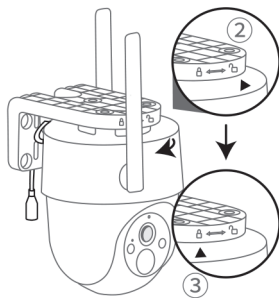
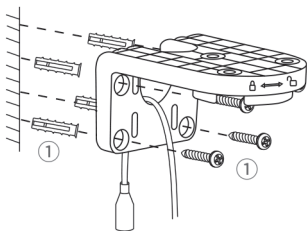
WALL MOUNTING





1. Drill 4 holes in the wall at the correct spacing. Insert the 4 wall plugs supplied and screw the angle bracket to the wall using the screws supplied and tighten them.
2. Insert the camera into the angle bracket and align the black arrow with the  symbol of the safety lock on the bracket.
3. Now turn the camera to the left until it clicks into place. The black arrow now points to the  symbol of the safety lock.

MOUNTING THE CAMERA II

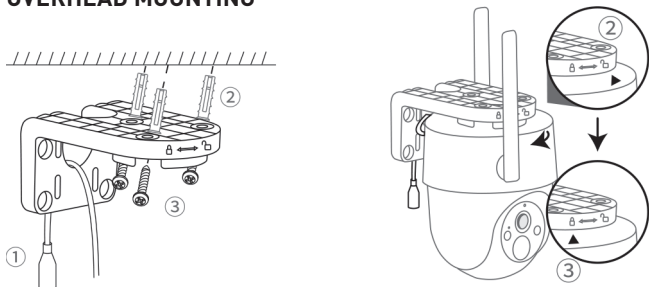

OVERHEAD MOUNTING



1. Drill 4 holes at the correct spacing in the ceiling or wall projection. Insert the 4 wall plugs supplied and screw the angle bracket to the ceiling or wall projection using the screws supplied and tighten them.
2. Insert the camera into the angle bracket and align the black arrow with the  symbol of the safety lock on the bracket.
3. Now turn the camera to the left until it clicks into place. The black arrow now points to the  symbol of the safety lock.

SETTING UP

1. Alternatively, you can simply set up the camera.
2. Simply turn the aerials upwards and place the camera firmly on the safety catch.
3. Deactivate 'Screen flip' in the app. You find the function in the camera settings > Image settings

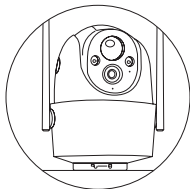



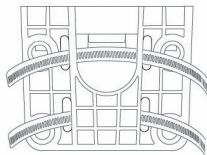

MOUNTING THE CAMERA III

MOUNTING ON A TREE OR POLE



1. 2 metal loops are included for attaching to a tree or pole. These can be used for fastening with a diameter of approx. 30mm to 270mm.
2. Remove the angle bracket from the camera and guide the loops through the existing holes.
3. Pull the metal loops around the tree or pole and push the end into the lug so that the bracket is firmly attached to the trunk. Close the loop with a Phillips screwdriver (not supplied).
4. Insert the camera into the angle bracket and align the black arrow with the safety lock symbol  on the bracket.
5. Now turn the camera to the left until it clicks into place. The black arrow now points to the safety lock symbol .

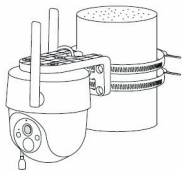

Tip:

You can also open the metal loops again with a Phillips screwdriver and move the camera to another location.

TECHNICAL DETAILS



Requirements	<ul style="list-style-type: none">• High-Speed-Internet• WiFi Connection• 2.4 GHz Frequency• Bluetooth compatible Smartphone
Data storage	<ul style="list-style-type: none">• Supports Micro-SD cards up to 512 GB• Micro-SD cards available separately (Requires class 10 oder higher)
Video	<ul style="list-style-type: none">• Resolution: 3MP 2304x1295 pxl. HD 25fps• Format: H.264 / H.265• Shutter speed: 1/20-1/10000s• Field of vision: 120°• Field of vision with pan and tilt function Function: 355°
Alarm triggering	<ul style="list-style-type: none">• Ultravision Motion Detection• Motion detection up to 30m range by day day
Image sensor	<ul style="list-style-type: none">• Night vision: up to 20 m (also in color)• Digital Wide Dynamic Range - For improving image quality with large differences in brightness• Color 0.1Lux@F2.0• 1/2.8" 3 Megapixel CMOS• Digital-Zoom
Audio	<ul style="list-style-type: none">• Front loudspeaker• Front microphone
Motion detection	<ul style="list-style-type: none">• Immediate push notifications via PetTec App when motion is detected
Dimensions & weight	<ul style="list-style-type: none">• Dimensions: 134x124x138mm• Weight: 637g
Integrated	<ul style="list-style-type: none">• Battery capacity: 10,400mAh



- rechargeable battery**
- Charging via USB-C cable via USB power adapter
 - Charging via solar panel possible
 - Battery life (depending on user behavior): up to 9 months
-

- Power supply**
- Consumption in stand-by mode: 200-800 μ A
 - Consumption in work mode: 150-200mA
 - Maximum power consumption: 4.5W
 - Rated power input (USB-C): DC 5V/1A
-

- Outdoor use**
- Protection class: IP65 - Weatherproof / protected against water jets
 - Temperature range: -20° to +50°

IMPORTANT INFORMATIONS

Radio signal

The radio transmission signal may be adversely affected by external influences (e.g., electric motors, defective electrical appliances). The range of the radio transmission signal is usually weaker within buildings than in the open field. Similarly, the structural works/conditions affect the radio range of the device. Bluetooth devices such as headphones or speakers can also negatively affect the radio signal of the device. The signal strength can also be reduced by environmental influences such as humidity.

Environmental protection

Please note that non-disposable electrical and electronic appliances as well as batteries must be recycled separately and in an environmentally friendly manner (European Directive on Waste Electrical and Electronic Equipment). Use the country-specific return and collection systems for the recycling of electrical and electronic appliances as well as for batteries. Disposal of batteries in household waste is prohibited.

TROUBLESHOOTING



My PetCam cannot be displayed correctly in the preview?

Check if the Wi-Fi network signal is strong. If not, you should move the device closer to the router or reset the device and add it to the app again.

Why is the device still in the device list after resetting?

When the device is reset, the network configuration is reset. To delete the device from the list, please start the app and delete your device.

How can I change the Wi-Fi network to another one?

First remove the device from the list and reset it. Then connect your phone to the new target Wi-Fi network and add the device to the app again.

Why does the device not recognise the micro SD card?

It is recommended to insert the card while the camera is switched off. Only then switch the camera on again. Check whether the card is recognised in another device and whether it has been formatted in FAT32 format. The micro SD card cannot be recognised if the internet connection is poor.

Why am I not receiving any notifications with the app?

Please make sure that the app is running on the phone and that the corresponding reminder function is activated. Also make sure that the permission to send notifications has been activated for this app in the settings of your smartphone.



CUSTOMER SERVICE

Declaration of conformity

Stage10 GmbH confirms that the product described in these instructions (Pet Cam Free'n 360° WiFi) conforms to guideline 2014/53/EU. The complete text of the EU declaration of conformity is available at the following URL:



<https://support.pettec.de/hc/de>



Declaration of conformity (see chapter „Declaration of conformity“): Products designated with this symbol fulfill all applicable community provisions of the European Economic Area.

MANUFACTURER INFORMATION AND SERVICE

If you have questions about the PetTec Free'n 360° WiFi or experience problems using it, first contact us via email at the following address:
info@PetTec.de

PetTec® is a brand of
Stage10 GmbH
Leipziger Platz 910117 Berlin
www.PetTec.com

You can find further information about our products, troubleshooting, and helpful tips at:

support.PetTec.de



DISPOSAL



Disposing of packaging

Please sort the packaging before disposal:

- Cardboard and paperboard with paper recycling
- Plastic wrap with recyclables



Disposal of devices

Applicable in the European Union and other European countries with systems for the separate collection of recyclables.



Do not dispose of used devices with household trash!

If your Pet Cam Free'n 360° WiFi is no longer usable, each user is obligated by law to dispose of used devices separately from household trash, e.g. at a collection site in your municipality. This ensures that used devices are recycled properly and that negative environmental effects are avoided. Therefore, electronic devices are marked with the symbol shown here.

PetTec

Pet Cam Free'n 360°

WiFi Version

PetTec© ist eine Marke der
Stage10 GmbH

Leipziger Platz 9
10117 Berlin
Germany



WEBSITE & SHOP
www.PetTec.com

INFOS, MANUALS & SUPPORT
support.PetTec.de

Pet Cam Free'n 360° WiFi
Art No. 16307

