

PetTec

Pet Cam Free'n 360°

4G/LTE Version

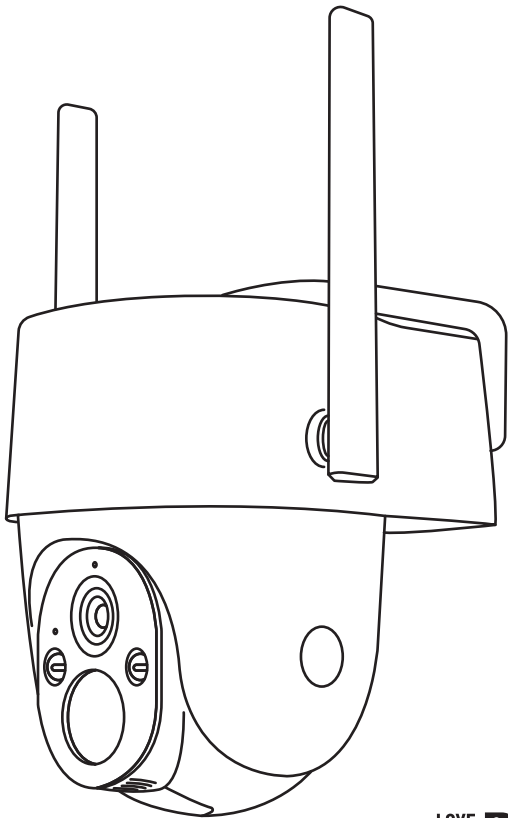

LOVE
YOUR **PET**



HERE WE GO...

Thank you for choosing our pet cam. With the **PetTec Pet Cam Free'n 360°** you'll always have your darling in view.

Important safety instructions

READ ALL INSTRUCTIONS AND WARNINGS IN THIS OPERATING MANUAL BEFORE USING THE PET CAM FREE'N 360°.

- Please do not disassemble and modify the PetTec Pet Cam Free'n 360°. The device requires neither maintenance nor servicing. In case of malfunction, please contact our customer service.
- In order to ensure proper use of the device, we recommend that you only use the original parts. Use only the supplied assembly parts for mounting the device.
- Keep the camera away from external exposure to ensure long term use. The device should not be affected by any renovation work, be it the use of paint or wallpaper.

Legal Notice

- The PetTec Pet Cam Free'n 360° has been designed for indoor and outdoor use only. Laws in your country may limit observation of areas outside of your home or property. Please inform yourself about local legislation. To protect the privacy of others, mount the camera so that you cannot record images of public areas, streets, or your neighbor's property. We also recommend informing relatives, visitors and domestic workers about the camera and its function.
- Please note that using the Pet Cam Free 360° does not automatically inform you via the app in emergencies or in the event of break-ins, for example. If necessary, an emergency call must always be made by you. Stage10 GmbH accepts no liability for missing or incorrect notifications or recordings.

PRODUCT OVERVIEW I

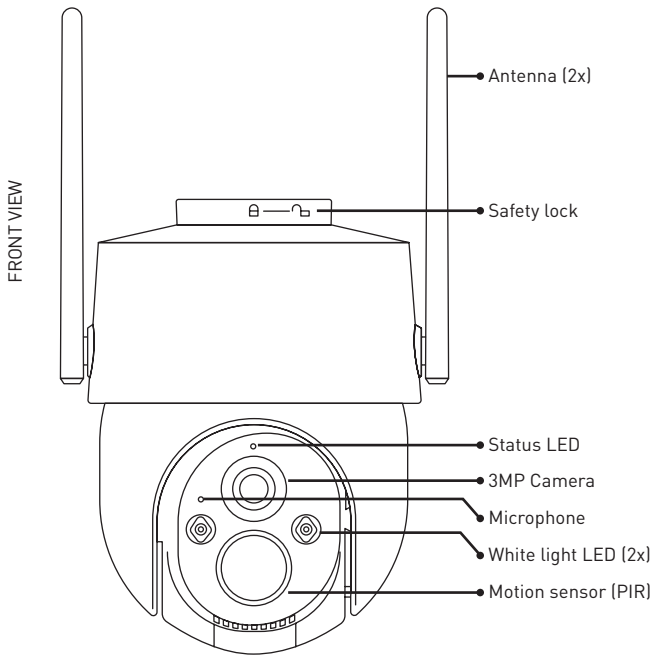



PRODUCT OVERVIEW II

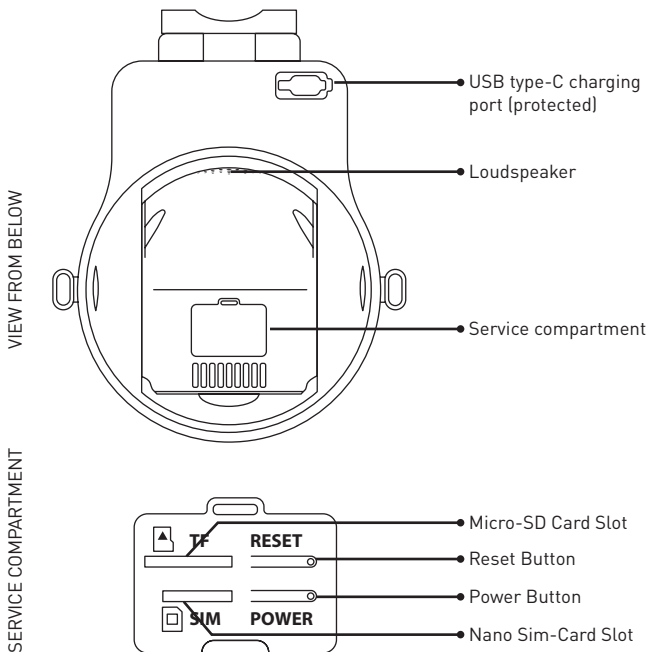

CONTENTS

- Pet Cam Free'n 360°
- Angle bracket
- 4 screws + dowels
- USB type-C Cable
- Manual

IMPORTANT INSTRUCTIONS



Status LED display

- Slowly flashing red LED - camera is started and ready to be connected to the app.
 - Red fast flashing LED - 4G/LTE connection is being established. Try reinserting the SIM card and/or resetting the camera if the LED flashes quickly for a longer period of time.
-
- Red and blue LED flashing alternately - connection to the app not possible! Please check whether the SIM card has been inserted correctly and the 4G/LTE service is active.
-
- Blue flashing LED - The camera is currently being initialised and connected
 - LED lights up blue - The camera is connected

Switching on and off

Press the power button in the service compartment for three seconds (until the LED lights up red) to switch the appliance on or off.

USB type-C cable

The connector supplies power to the camera. If required, conventional USB type-C cables with different lengths may be used.

Microphone/speaker

The combination of built-in microphone and speaker allows two-way communication.

Micro-SD card slot

The micro-SD card slot is located at the top of the treat tank under a cover (see diagram). Micro-SD cards up to 512 GB may be used.

Reset Button

The reset button must be pressed for approx. 5 seconds to reset the camera to the factory settings.



4G / LTE USAGE

The **Pet Cam Free'n 360°** offers various options to ensure a permanent connection with the app.

Mobile radio 4G / LTE

This is a good option if you want to position the camera freely without having to worry about WiFi coverage. There are two alternatives:

1. built-in e-Sim with service via the PetTec app

You can easily book a fast 4G/LTE service via the PetTec app. If the mobile phone coverage at the camera's location is good, you don't have to worry about anything else.

2. own LTE tariff with multi-sim

If you have your own mobile phone tariff that supports LTE and the multi-sim option (several sim cards in one contract), you can also use your own Nano Sim card. Please note, however, that the data volume can be considerable depending on the options selected.

Ready to go with 4G/LTE

So that you can start using the camera immediately, we are giving you 3 days of LTE use with the built-in e-Sim. The duration starts to run from the time of commissioning (see there) and connection of the app with the Pet Cam Free'n 360°.

If you pass the camera on to someone else - and it is connected to a new Pet-Tec user account - the 3 days start again from the beginning. So everyone can immediately test the camera's many functions.

Fair use: This is possible up to 4 times.

Use your own SIM card

The Pet Cam Free'n 360 supports numerous SIM cards from 4G/LTE mobile phone providers. If your SIM card is not automatically supported, you can simply enter the necessary data in the PetTec app during the camera connection process. Your 4G/LTE SIM card will then also be supported. You can find out more about this in the FAQ and during the connection process in the app!

GETTING STARTED



1. Please connect the camera with a USB type-C cable and plug it into the charger plug. The power plug must be connected to a power outlet.
2. After about a minute, the camera will beep and the LED will flash red. This signals that the camera is ready to connect to the app.
3. The camera is connected to the PetTec app via 4G/LTE. The permanent connection between the camera and the app or your smartphone is established using 4G LTE technology. To do this, you can either use the paid service from PetTec or use your own 4G LTE SIM card. **To do this, you must insert the SIM card into the Nano SIM card slot of the camera.**
4. When using your own SIM card, ensure the radio quality and compatibility! Always check the quality of the wireless connection before permanently installing the camera at a location!
5. The use of a 4G LTE service is mandatory to use the full functionality of the camera. You can use your own 4G LTE SIM card or use our integrated e-SIM and book the service via the PetTec app

Important: Fully charge the device when using it for the first time or after a longer break. This can take up to 4 hours!





FEATURES

Pan/tilt

The camera image can be rotated/tilted in the app to obtain a viewing angle of almost 360 degrees.

Colour Vision

Thanks to the two white light LEDs, the recorded images and videos of motion detection are in colour.

Two-way audio

If you see a visitor in the camera's live view, you can speak to them and communicate with them via your app function.

PIR

If someone walks past, an alarm is triggered and sent to your smartphone.

Motion detection

The camera can be activated from a great distance (up to 30 metres) by detecting people. The camera sends you push notifications and app notifications as soon as human movement is detected.

Recording

Use a micro SD card or save events with the Cloud Event Service Cloud+ so you never miss a thing.

Day&Night

With the powerful night vision technology, you have a good view even in the dark (up to 20m).

AOV (Always on Video)



By using the latest AOV technology, the Pet Cam Free'n 360° enables permanent recording and event detection up to a distance of 30 metres. If a person is detected, the device immediately switches to live recording. If no person is detected, the device records energy and memory-saving videos at a frame rate set by the user.

MOUNTING THE CAMERA

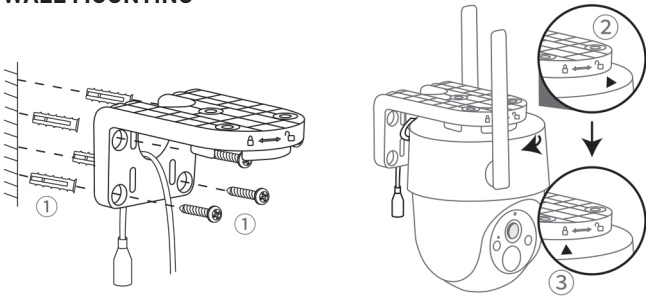

WALL MOUNTING





1. Drill 4 holes in the wall at the correct spacing. Insert the 4 wall plugs supplied and screw the angle bracket to the wall using the screws supplied and tighten them.
2. Insert the camera into the angle bracket and align the black arrow with the  symbol of the safety lock on the bracket.
3. Now turn the camera to the left until it clicks into place. The black arrow now points to the  symbol of the safety lock.

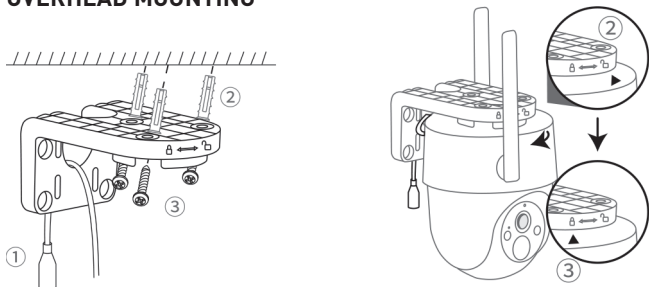

OVERHEAD MOUNTING



1. Drill 4 holes at the correct spacing in the ceiling or wall projection. Insert the 4 wall plugs supplied and screw the angle bracket to the ceiling or wall projection using the screws supplied and tighten them.
2. Insert the camera into the angle bracket and align the black arrow with the  symbol of the safety lock on the bracket.
3. Now turn the camera to the left until it clicks into place. The black arrow now points to the  symbol of the safety lock.

SETTING UP

1. Alternatively, you can simply set up the camera.
2. Simply turn the aerials upwards and place the camera firmly on the safety catch.
3. Deactivate 'Screen flip' in the app. You find the function in the camera settings > Image settings

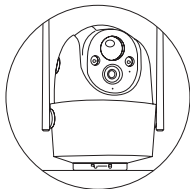

TECHNICAL DETAILS



Requirements

- PetTec e-Sim service with unlimited monthly data volume (subject to a charge, see PetTec app for prices)
- **OR** Own Nano Sim card with active 4G/LTE service and sufficient data volume

Data storage

- Supports Micro-SD cards up to 512 GB
- Micro-SD cards available separately (Requires class 10 or higher)

Video

- Resolution: 3MP 2304x1296 pxl. HD 25fps
- Format: H.264
- Shutter speed: 1/20-1/10000s
- Field of vision: 120°
- Field of vision with pan and tilt function
Function: 355°

Alarm triggering

- Ultravision Motion Detection
- Motion detection up to 30m range by day

Image sensor

- Night vision: up to 20 m (also in color)
- Digital Wide Dynamic Range - For improving image quality with large differences in brightness
- Color 0.1Lux@F2.0
- 1/2.8" 3 Megapixel CMOS
- Digital-Zoom

Audio

- Front loudspeaker
- Front microphone

Motion detection

- Immediate push notifications via PetTec App when motion is detected

Dimensions & weight

- Dimensions: 134x124x138mm
- Weight: 637g

**Integrated rechargeable battery**

- Battery capacity: 10,400mAh
- Charging via USB-C cable via USB power adapter
- Charging via solar panel possible
- Battery life (depending on user behavior): up to 9 months

Power supply

- Consumption in stand-by mode: 200-800 μ A
- Consumption in work mode: 150-200mA
- Maximum power consumption: 4.5W
- Rated power input (USB-C): DC 5V/1A

Outdoor use

- Protection class: IP65 - Weatherproof / protected against water jets
- Temperature range: -20° to +50°

IMPORTANT INFORMATIONS

Requires sufficient 4G LTE radio signal

When installing the camera, it must be ensured that the 4G LTE service provider used provides sufficiently good network quality. Therefore, check the LTE connection first and only attach the camera after a good connection has been ensured.

Radio signal

The radio transmission signal may be adversely affected by external influences (e.g., electric motors, defective electrical appliances). The range of the radio transmission signal is usually weaker within buildings than in the open field. Similarly, the structural works/conditions affect the radio range of the device. Bluetooth devices such as headphones or speakers can also negatively affect the radio signal of the device. The signal strength can also be reduced by environmental influences such as humidity.

Environmental protection

Please note that non-disposable electrical and electronic appliances as well as batteries must be recycled separately and in an environmentally friendly manner (European Directive on Waste Electrical and Electronic Equipment). Use the country-specific return and collection systems for the recycling of electrical and electronic appliances as well as for batteries. Disposal of batteries in household waste is prohibited.

TROUBLESHOOTING



My PetCam cannot be displayed correctly in the preview?

Check whether the network quality at the PetCam installation site is good enough. If this is not the case, select a different location.

Why is the device still in the device list after resetting?

When the device is reset, the network configuration is reset. To delete the device from the list, please start the app and delete your device.

How can I change the Wi-Fi network to another one?

First remove the device from the list and reset it. Then connect your phone to the new target Wi-Fi network and add the device to the app again.

Why does the device not recognise the micro SD card?

It is recommended to insert the card while the camera is switched off. Only then switch the camera on again. Check whether the card is recognised in another device and whether it has been formatted in FAT32 format. The micro SD card cannot be recognised if the internet connection is poor.

Why am I not receiving any notifications with the app?

Please make sure that the app is running on the phone and that the corresponding reminder function is activated. Also make sure that the permission to send notifications has been activated for this app in the settings of your smartphone.



CUSTOMER SERVICE

Declaration of conformity

Stage10 GmbH confirms that the product described in these instructions (Pet Cam Free'n 360°) conforms to guideline 2014/53/EU. The complete text of the EU declaration of conformity is available at the following URL:



<https://support.pettec.de/hc/de>



Declaration of conformity (see chapter „Declaration of conformity“): Products designated with this symbol fulfill all applicable community provisions of the European Economic Area.

MANUFACTURER INFORMATION AND SERVICE

If you have questions about the PetTec Free'n 360° or experience problems using it, first contact us via email at the following address:
info@PetTec.de

PetTec® is a brand of
Stage10 GmbH
Leipziger Platz 910117 Berlin
www.PetTec.com

You can find further information about our products, troubleshooting, and helpful tips at:

support.PetTec.de



DISPOSAL



Disposing of packaging

Please sort the packaging before disposal:

- Cardboard and paperboard with paper recycling
- Plastic wrap with recyclables



Disposal of devices

Applicable in the European Union and other European countries with systems for the separate collection of recyclables.

Do not dispose of used devices with household trash!

If your Pet Cam Free'n 360° is no longer usable, each user is obligated by law to dispose of used devices separately from household trash, e.g. at a collection site in your municipality. This ensures that used devices are recycled properly and that negative environmental effects are avoided. Therefore, electronic devices are marked with the symbol shown here.

PetTec

Pet Cam Free'n 360°

4G/LTE Version

PetTec© ist eine Marke der
Stage10 GmbH

Leipziger Platz 9
10117 Berlin
Germany

WEBSITE & SHOP

www.PetTec.com

INFOS, MANUALS & SUPPORT

support.PetTec.de



Pet Cam Free'n 360°

4G/LTE Version

Art No. 16299

